

BULLNOSED KERB
N.T.S.

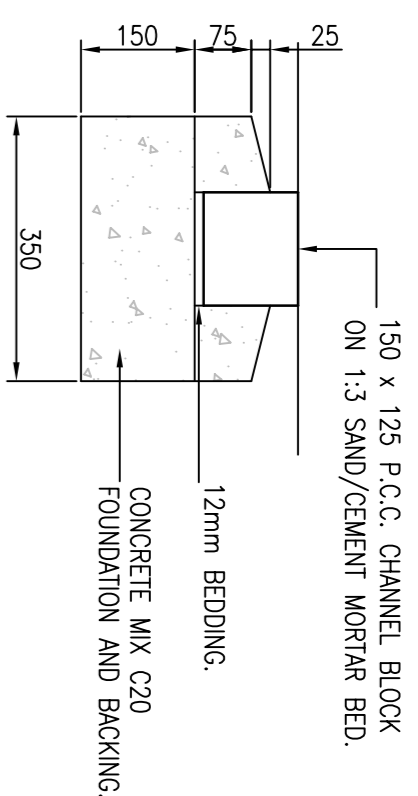

CHANNEL BLOCK
N.T.S.

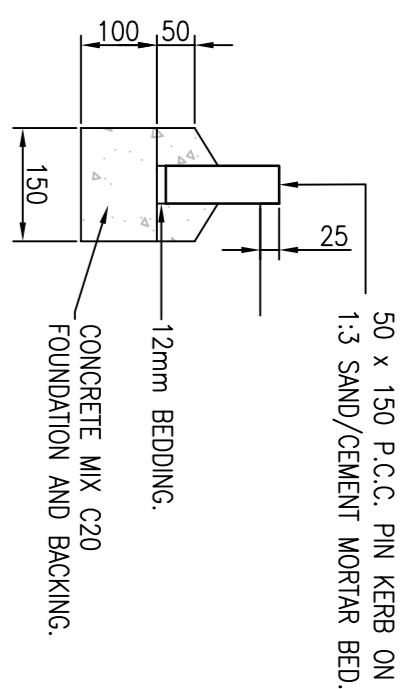

PIN KERB WITH UPSTAND
N.T.S.

NOTE
WHINSTONE SETTS DIMENSIONS TO BE CONFIRMED BY GLEN KEMP.

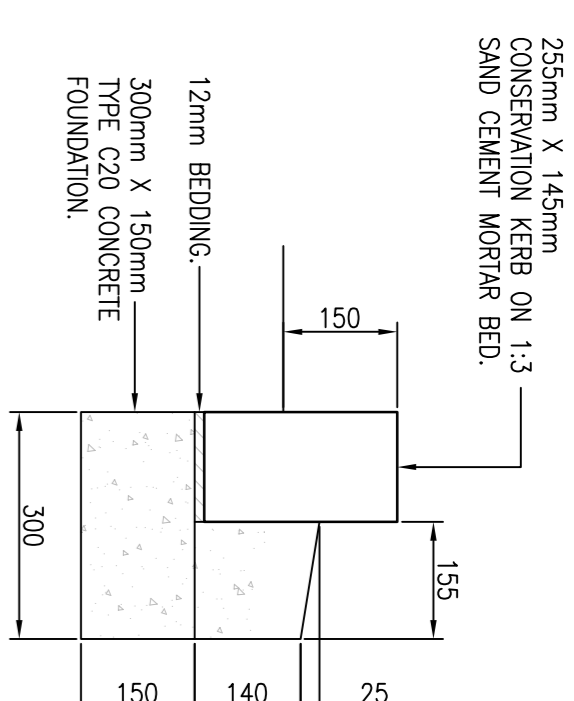

CONSERVATION KERB DETAIL
N.T.S.

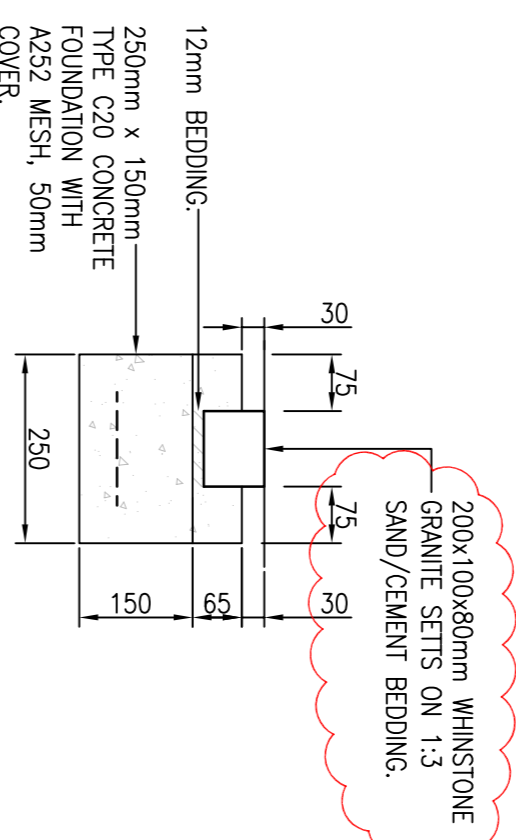

TRAFFICKED WHINSTONE GRANITE SETTS KERB DETAIL.
0mm UPSTAND
N.T.S.

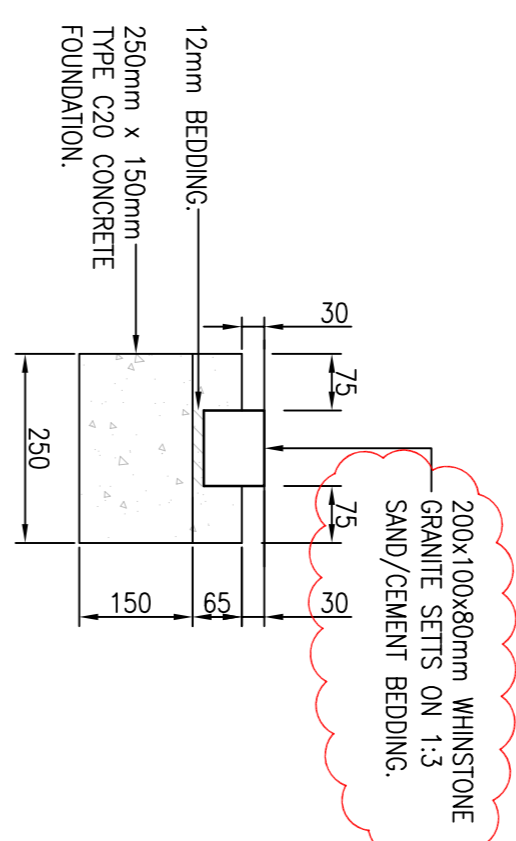

UNTRAFFICKED WHINSTONE GRANITE SETTS KERB DETAIL.
0mm UPSTAND
N.T.S.

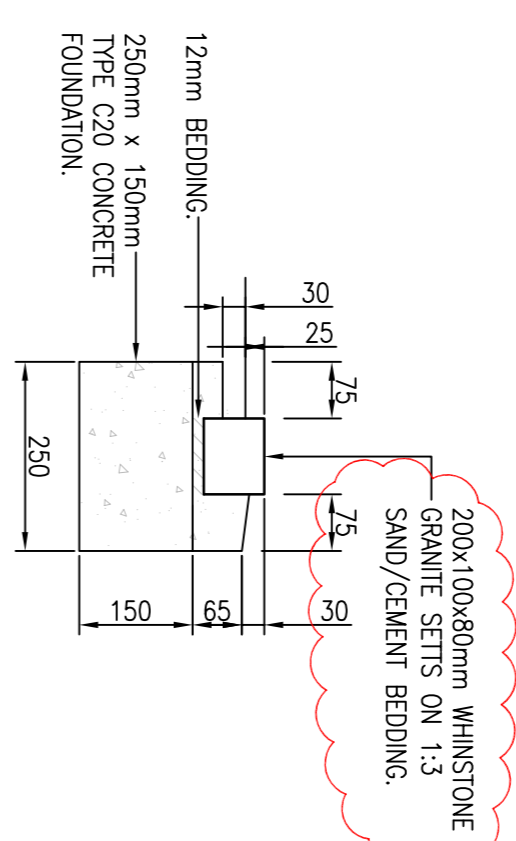

UNTRAFFICKED WHINSTONE GRANITE SETTS KERB DETAIL.
25mm UPSTAND
N.T.S.

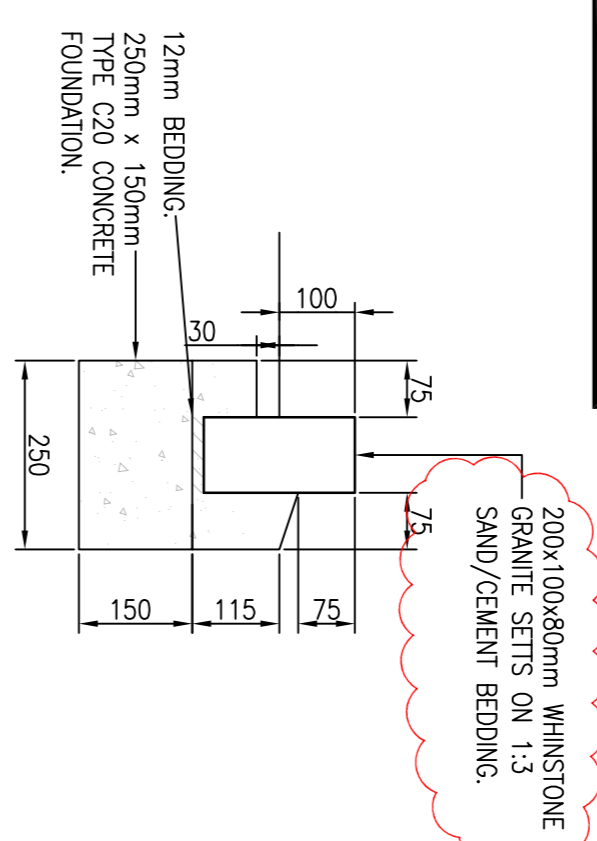

UNTRAFFICKED WHINSTONE GRANITE SETTS KERB DETAIL.
100mm UPSTAND
N.T.S.

- General Notes**
- The drawing is Copyright and should not be reproduced in whole or part without the written consent of the Engineer.
 - The drawing is to be read in conjunction with all relevant Patrick Parsons Ltd drawings & specifications.
- NOTES**
- SUBSTITUTES INSULATION MATERIAL MUST BE FOLLOWED FOR EACH PROPRIETARY SYSTEM
 - PRE-DRAINING, STRIPPER, SOUND PROPRIETARY BLEND SPURTS/JOINT CONSTRUCTION & MANUAL X DRENCHER AS A 60-60 SAND BLEND. THE USE OF SITE WORN MATERIALS OR IN SITU SELF-BENDING IS NOT RECOMMENDED
 - MINIMUM SLOPE 1:100
 - TO 8402 FOR SURFACE DETAILS INCLUDING COLIERS.

Revisions	
R01	CONSTRUCTION ISSUE
	14.10.15 RB

PATRICK PARSONS
consulting engineers

Waterloo House
25 Abchurch Lane
Newcastle upon Tyne
NE1 4AP
United Kingdom
T: +44 (0)191 261 9000
E: info@patrickparsons.co.uk
W: www.patrikparsons.co.uk

Client
NORTHUMBERLAND NATIONAL PARK

Project
THE SILL CSEC, HEXHAM

Drawings
HIGHWAY CONSTRUCTION DETAILS
SHEET 2 OF 2

Scales N.T.S.

Drawn	GW	Checked	AC
Date	DEC 2013		

Status CONSTRUCTION

Drawing No. **SL-PP-00-XX-DR-C-281** Rev: **C01**